

Lithium Iron Phosphate (LiFePO4) Battery Specification

SLAUMXLI84-24(25.6V84AH)

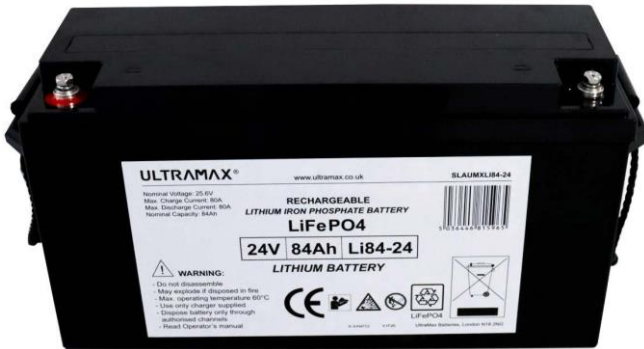

Outer dimensions (mm)

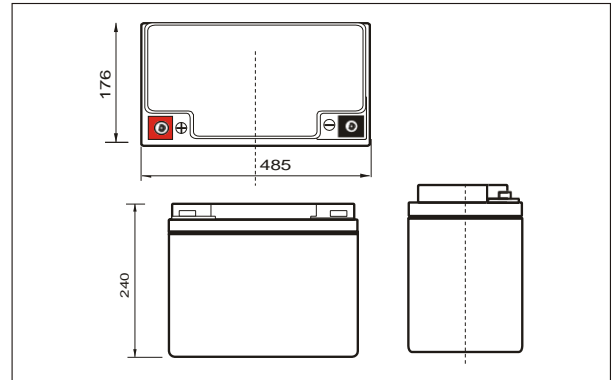

Specifications

Nominal Voltage		25.6V
Rated capacity (20 hour rate)		84Ah
Dimensions	Total Height	240 mm
	Height	240 mm
	Length	485 mm
	Width	176 mm
Weight Approx		19.92 Kg
Terminal		M8

Terminal Type (mm)

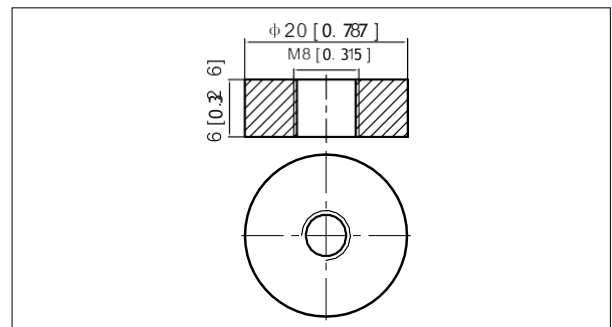

Characteristics

Capacity Retention	>80% at 28 days	
Cycle Life	>80% at 2000 Cycles	
1.5 hour discharge to 29.2V	3.00 A	
Internal Resistance	<20 mΩ	
Charge Characteristics	Charge Voltage	29.2±0.1V
	Charger Current	<80A
Discharge Characteristics	Max Continuous Current	80A
	Min Discharge Cut-off Voltage	20V
Temperature	Charge Temperature	0°C-45°C(32°F-113°F)
	Discharge Temperature	-20°C-60°C(-4°F-140°F)
	Storage Temperature	0°C-40°C(32°F-104°F)

Discharge Curves 25°C(77°F)

