

## Lithium Iron Phosphate (LiFePO4) Battery Specification

**SLAUMXLI60-12(12.8V60AH)**

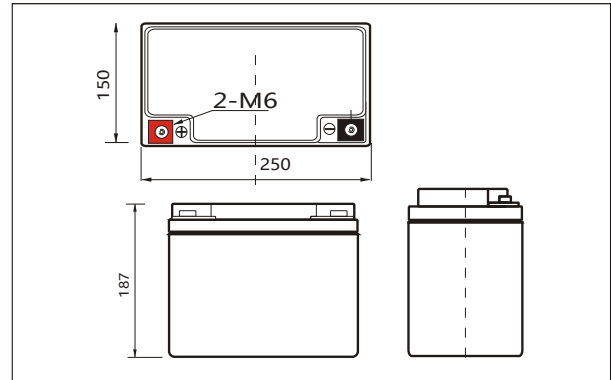

### Outer dimensions (mm)



### Specifications

Nominal Voltage		12.8V
Rated capacity (20 hour rate)		60Ah
Dimensions	Total Height	187 mm
	Height	187 mm
	Length	250 mm
	Width	150 mm
Weight Approx		7.2 Kg
Terminal		M6

### Terminal Type (mm)

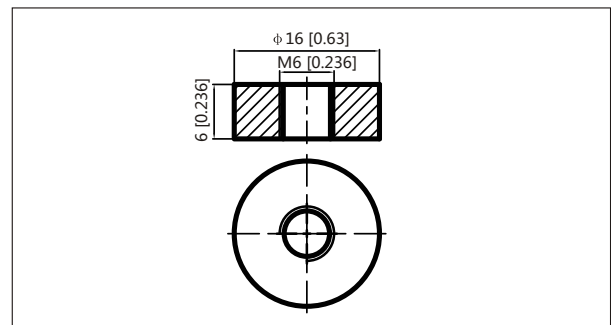

### Characteristics

Capacity Retention	>80% at 28 days	
Cycle Life	>80% at 2000 Cycles	
1.5 hour discharge to 10.5V	3.00 A	
Internal Resistance	<50 mΩ	
Charge Characteristics	Charge Voltage	14.6±0.1V
	Charger Current	<50A
Discharge Characteristics	Max Continuous Current	60A
	Min Discharge Cut-off Voltage	10V
Temperature	Charge Temperature	0°C-45°C(32°F-113°F)
	Discharge Temperature	-20°C-60°C(-4°F-140°F)
	Storage Temperature	0°C-40°C(32°F-104°F)

### Discharge Curves 25°C(77 °F)

