

Lithium Iron Phosphate (LiFePO4) Battery Specification

SLAUMXLI55-12(12.6V55AH)



Specifications

Nominal Voltage		12.6V
Rated capacity (20 hour rate)		55Ah
Dimensions	Total Height	220mm(8.66inches)
	Height	220mm(8.66inches)
	Length	230mm(9.06inches)
	Width	139mm(5.4inches)
Weight Approx		6.5Kg (14.3lbs)
Terminal		M6

Characteristics

Capacity Retention	>80% at 28 days	
Cycle Life	>80% at 1500 Cycles	
1.5 hour discharge to 10.5V	9.0 A	
Internal Resistance	<80 mΩ	
Charge Characteristics	Charge Voltage	14.4±0.1V
	Charger Current	<50A
Discharge Characteristics	Continuous Current	50A
	Max. Pulse Current	150A(<5ms)
	Discharge Cut-off Voltage	8V
Temperature	Charge Temperature	0°C-45°C(32°F-113°F)
	Discharge Temperature	-20°C-60°C(-4°F-140°F)
	Storage Temperature	0°C-40°C(32°F-104°F)

Outer dimensions (mm)

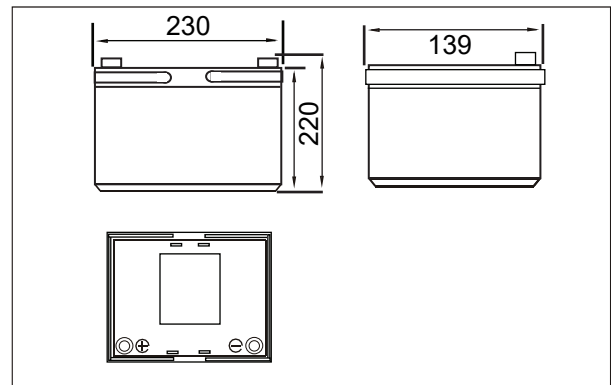

Terminal Type (mm)

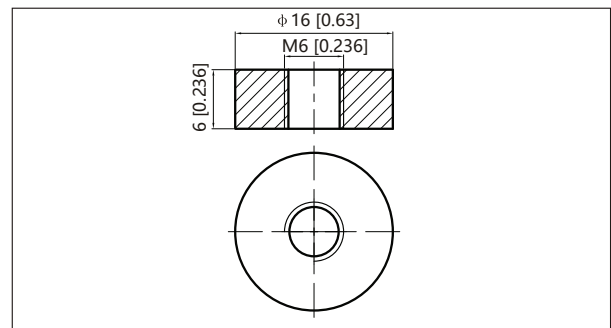

Discharge Curves 25°C(77 °F)

