

NPL SERIES - **NPL65-12I**

NPL Valve Regulated Lead-acid Batteries (VRLA)

The NPL range is an enhanced NP design resulting in a longer service life (7 - 10yrs). All other attributes and operational characteristics are the same, thereby maintaining the benefit of a common mechanical and electrical design for users of both products.

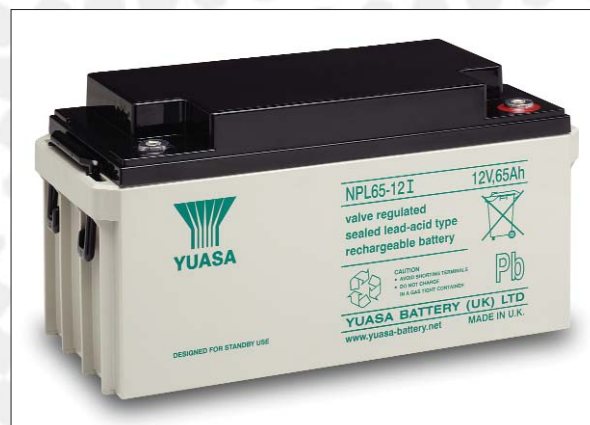

FEATURES

- Yuasa VRLA batteries can be used in any orientation excluding continuous use inverted.
- Standard case material is flame retardant to (UL94) HBØ.
- FR option case material is flame retardant to UL94:VØ (oxygen index 30).
- NPL batteries are manufactured in factories that comply with ISO 9001:2000.
- FR option NPLs comply with BS6290 Part 4 (1997).
- NPL batteries comply with IEC 60896-21+22.

Layout

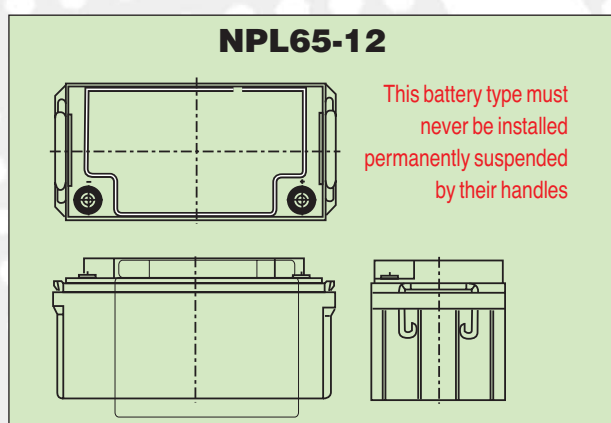

Terminals

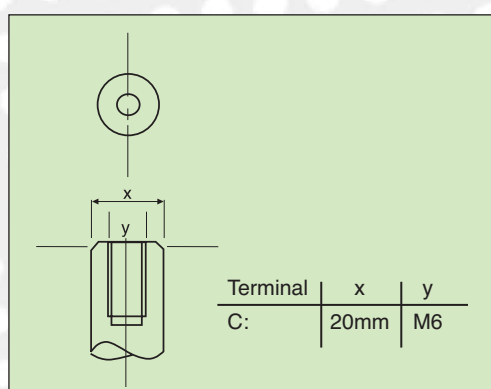

Operational Temperature Range

Charge	-15°C to 50°C
Discharge	-20°C to 60°C
Storage	-20°C to 50°C (fully charged condition)

General Specifications

Nominal Capacity (Ah)	NPL65-12I
20hr to 1.75vpc 20°C	65
10hr to 1.75vpc 20°C	60.5
5hr to 1.70vpc 20°C	55.3
1hr to 1.60vpc 20°C	39
Voltage	12
Energy Density (Wh/L)	77
Specific Energy (Wh. kg)	34
Int Resistance (m.ohms)	5
Maximum discharge (A)	500
Short Circuit current	800
Dimensions (mm) +/- 2mm	
Length	350
Width	166
Height overall	174
Weight	23
Terminal	C
Torque (Nm)	4.76

Applications

- Security and Fire
- UPS
- Telecoms
- Emergency Lighting

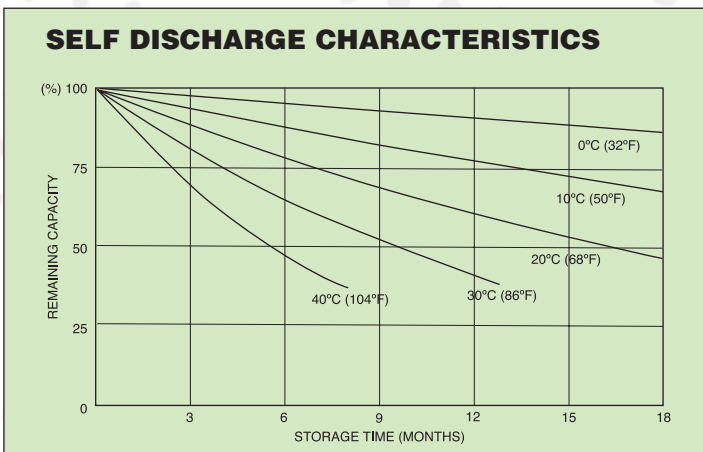
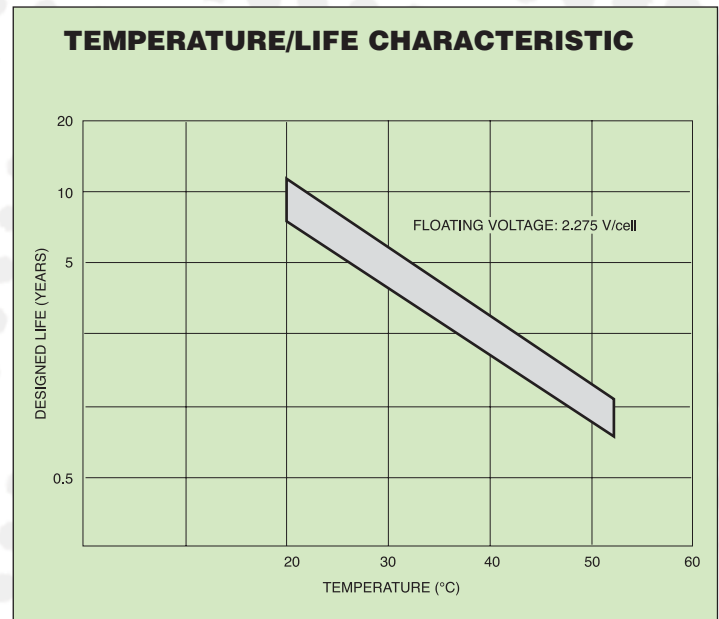
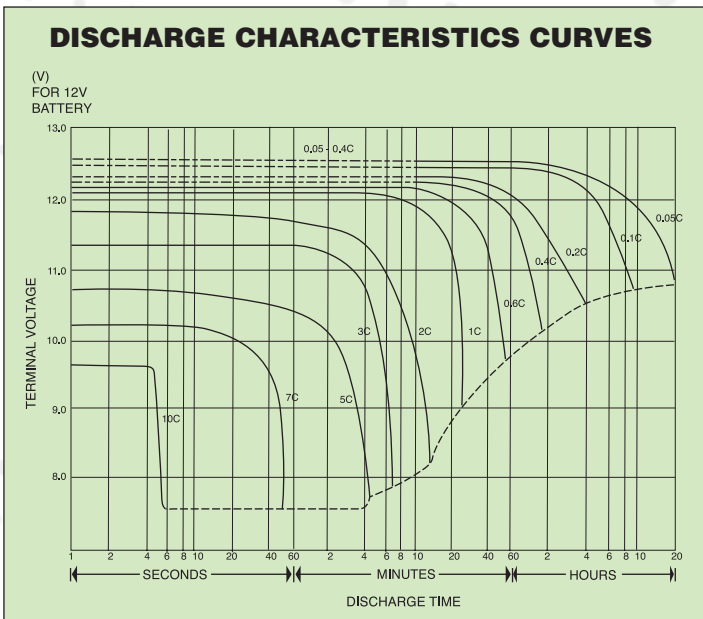
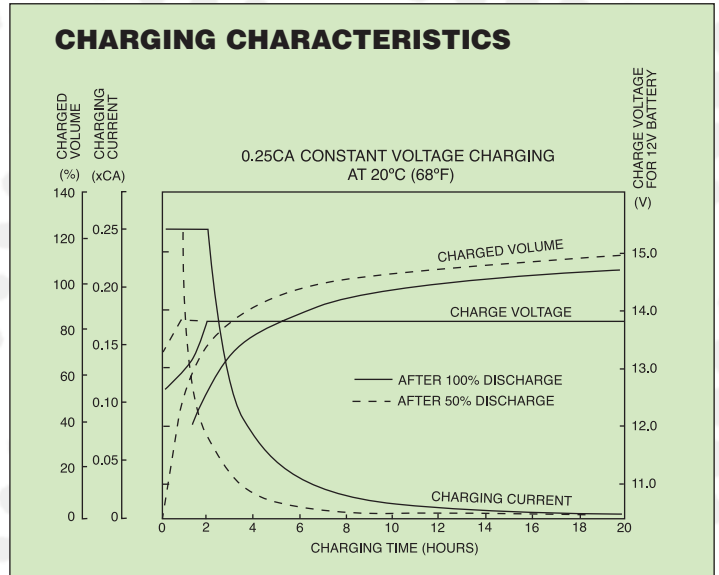
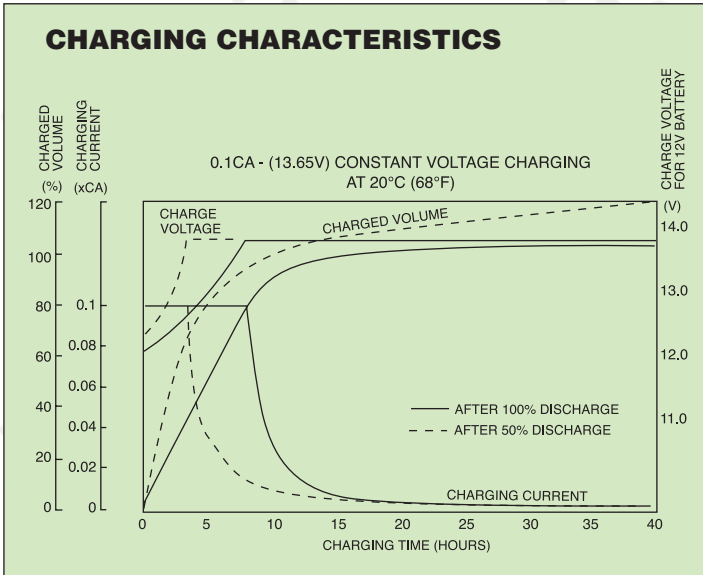

Charging Methods (at 20°C)

Standby use: Float charging voltage 2.275vpc

CAUTION

- Avoid short circuit.
- Do not charge in a sealed container.
- Service life and operational characteristics will be affected by temperature.
- AC Ripple reduces service life.



Yuasa Battery Sales (UK) Ltd

Unit 22 Rassau Industrial Estate
Ebbw Vale, Gwent, NP23 5SD
Tel: 08708 500312 Fax: 08708 500317
E-mail: enquiries@yuasa-sales.co.uk

Registered number 1548820

Cat. No. NPL65-12I February 07

E&O.E.

Distributed by